

AXIAL FAN

Unit:axial fan motor

Type:

Motor:single phase motor with capacitor

Customer:

Motor type:MTA100RF

Customer type:

Type	Voltage V	Frequency Hz	Input power W	Current A	Speed r/min ±5%	Air volume m³/h	Noise level dBA	Capacitor μF/VDB
MTA100RF	220	50	55	0.25	1400	780	55	2 μF/450V

Insulation class : B

Operating type: S1

Permissible ambient temperature : -30~60°C Temperature increase: $\Delta T \leq 85k$

Motor protection:thermocontact 150±5°C

Bearings: ball bearings

License: CE

Model meanings:

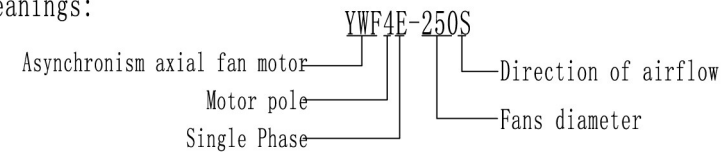

Electrical connection:lead wire 0.50mm

Direction of rotation:clockwise(sucking), Airflow direction:"S" looking at rotor side

High-voltage test according to EN 60335-1 1800V

Material/Surface treatment:rotor with condensation drain holes varnished black, stator temperature protected

Balance grade:G6.3 Fan balanced dynamically in two planes

APPROX. WEIGHT

MEANS

DRN. BY

CHD. BY

ENG. BY

APP. BY

A4

SCALE

SHEET: of

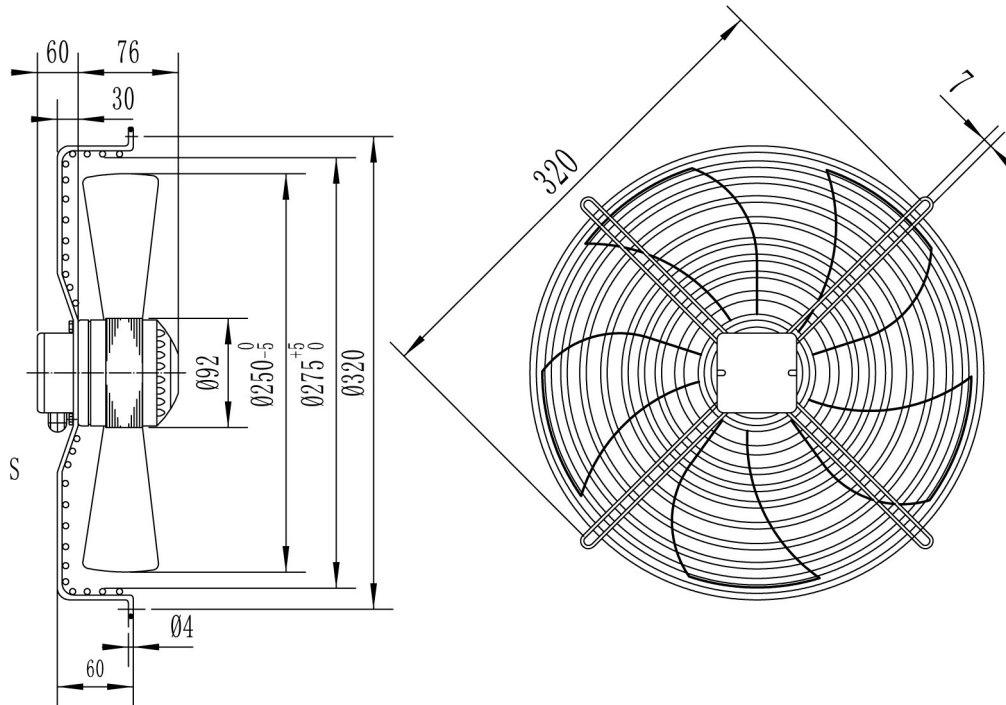

MTA100RF AXIAL FAN MOTOR

220V 50Hz 0.25A 55W

2 μF/450V 1400r/min CL.B



SINGLE-PHASE WIRING DIAGRAM

